



GRAMMER
office

NowyStyl

GRAMMERoffice
projects



COLLECTION

office *sport stadiums* *theatres* *conference rooms* *concert halls*
cinemas *auditoriums* *large multipurpose spaces*
terminals & waiting areas *convention centres* *universities & schools*

sayılarla **NowyStyl** *in numbers*

tesis ve ofis sayısı

24

facilities and offices

çalışan sayısı

3500

number of employees

2023 cirosu

310.000.000 €

turnover in 2023

ISO

9001:2008

ISO

14001:2004

yaklaşık üretim alanı

210,000 m²

approximate production area

üretim tesisi

6

production plants

ürün markası

5

product brands

countries where products are shipped

70+

ürün gönderimi yapılan ülkeler

showroom sayısı

28

showrooms

years of warranty

5

yıl garanti

Showroom Istanbul



TCC-THE CHAIR COMPANY BÜRO KOLTUK SAN. VE TİC. A.Ş.

1880 yılında Almanya'nın Amberg kentinde Willibald Grammer tarafından kurulan GRAMMER AG firmasının bünyesinde faaliyetlerine başlamıştır. Ülkemizde, 1985 yılında Bursa'da kurduğu modern entegre tesislerinde en ileri Alman teknolojisi ile Türkiye'de ilk amortisörlü koltuğun üretimine başlamıştır. 2014 yılında Anonim Şirket statüsüne geçip TCC-The Chair Company Büro Koltuk San. ve Tic. A.Ş. unvanını alarak Nowy Styl bünyesine dâhil olmuştur. Grammer Office, TCC, Grammer Office Projects markaları altında toplanan zengin ürün portföyü ile, ofis, konferans, sinema, tiyatro, oditoryum, derslik, stadyum ve terminaller için oturma çözümleri sunmaktadır.

Started its operations as a part of GRAMMER AG, founded in the year 1880 by Willibald Grammer In Amberg, Germany. In 1985 we established our fully integrated facilities in Bursa with the most advanced German technology and manufactured the first Office Chair with a gas lift of Turkey. In 2014, TCC-The Chair Company Büro Koltuk San. Tic. A.Ş. became a member of Nowy Styl. We produce and distribute seating solutions for offices, conferences, cinemas, theaters, auditoriums, classrooms, stadiums and terminals with our well-known brands Grammer Office, TCC and Grammer Office Projects.

1880 - 2026

146 yıldır
aynı tutku ve heyecan ile
sadece koltuk üretiyoruz...

Over 146 years
we **only produce seats** with the
same passion and excitement...



Klasik mekanizmalara sahip ofis koltukları
Office chairs with conventional mechanisms



Dünya çapında patentli Glide-Tec® teknolojisine sahip ofis koltukları
Office chairs with worldwide patented Glide-Tec® technology

NowyStyl

Ofis ve kamusal alanlar için kapsamlı mobilya çözümlerinde Avrupa lideri marka. Benzersiz iş modeli sayesinde, müşterilerin ihtiyaçlarının, verimliliğinin, iş organizasyonunun, ergonominin ve akustiğin derinlemesine analizine dayanan mükemmel bir iç dekorasyon hizmeti sunar. Tecrübesi, teknoloji ve üretim tesisleri ile her teklifin "kişiye özel" olmasını sağlar.

European leader in comprehensive furniture solutions for office and public spaces. Thanks to its unique business model, the brand offers an excellent interior furnishing service based on in-depth analysis of clients' needs, efficiency, work organisation, ergonomics and acoustics. The experience as well as technological and production facilities ensure that every offer is "tailor-made."



Konferans, tiyatro, sinema, oditoryum, derslik, stadyum, terminal ve çok amaçlı salon koltukları
Seating solutions for conference, theatre, cinema, auditorium, classroom, stadium, terminal and multi-purpose halls

ÖDÜLLERİMİZ

AWARDS

DESIGNERS

TASARIMCILAR

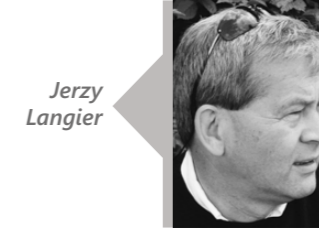
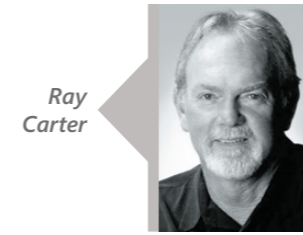
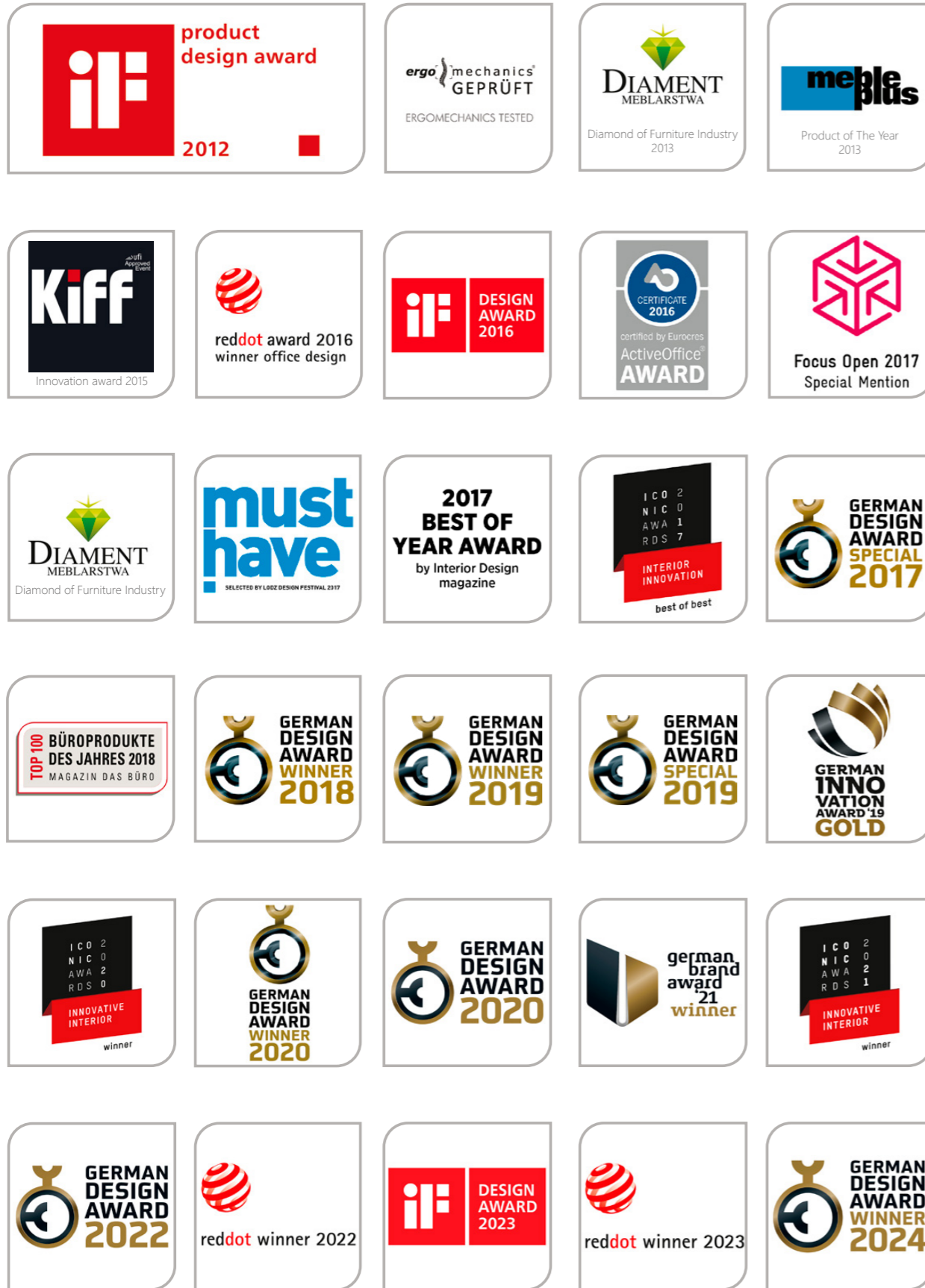

GRAMMER
office

NowyStyl



01

Executive Ofis ve Müdür Koltukları
Executive Office and Managerial Chairs

02

Operasyonel Ofis Koltukları
*Operative Office Chairs*TCC
The Chair Company

NowyStyl



03

Sofa ve Bekleme Koltukları
Sofas and Visitor Chairs

04

Kafe Koltukları
*Café Chairs*GRAMMERoffice
projects

05

Konferans, Tiyatro, Sinema, Oditoryum, Derslik ve Terminal Koltukları
*Conference, Theatre, Cinema, Auditorium, Classroom and Terminal Chairs*01 Executive Ofis ve Müdür Koltukları
Executive Office and Managerial Chairs

- 18 YouTEAM™
- 22 Tiger Up
- 26 Sail
- 30 HIP HOP

03 Sofa ve Bekleme Koltukları
Sofas and Visitor Chairs

- 74 Fresh!
- 75 Reto
- 76 Poly
- 78 Match
- 80 Kaika
- 82 Eva
- 84 Tilkka
- 88 Ciao!
- 90 Tutti
- 92 Athinas
- 94 Comodo
- 96 Mood
- 98 Club
- 100 Gala
- 102 Concerto
- 104 Estudio
- 106 Magnes II
- 110 Hexa

05 Konferans, Tiyatro, Sinema, Oditoryum, Derslik ve Terminal Koltukları
Conference, Theatre, Cinema, Auditorium, Classroom and Terminal Chairs

- 126 Oscar
- 130 Tondo
- 132 Swing
- 134 Pablo
- 138 Event
- 140 Liza
- 144 Richard
- 148 Newton
- 152 Divo
- 156 Polyphony
- 160 Tom
- 162 Roma
- 164 Unit
- 166 Sempre
- 170 Theo
- 172 Vision
- 176 Vision HT
- 178 College

02 Operasyonel Ofis Koltukları
Operative Office Chairs

- 36 WithME
- 40 Bello
- 44 S-Line
- 48 4ME&2ME
- 52 Trevo
- 54 Frame
- 56 Navigo
- 58 Wave
- 62 Uno
- 64 Basis Mesh
- 66 Basis
- 67 Emo II
- 68 Deal
- 69 Line
- 70 CPC

04 Kafe Koltukları
Café Chairs

- 116 Fondo
- 118 Macao
- 119 James
- 119 Glen
- 120 Café
- 122 Beta
- 123 Amigo

- 182 Foster
- 186 Henry
- 187 Enviro
- 190 Axo
- 194 Cadira
- 196 Scuola
- 198 Anno
- 200 Fly II 3D

01

Executive Ofis ve
Müdür Koltukları

*Executive Office and
Managerial Chairs*

GRAMMER
office

NowyStyl

02

Operasyonel Ofis Koltukları
Operative Office Chairs

03

Sofa ve Bekleme Koltukları
Sofas and Visitor Chairs

04

Kafe Koltukları
Café Chairs

05

Konferans, Tiyatro, Sinema,
Oditoryum, Derslik ve
Terminal Koltukları
*Conference, Theatre, Cinema,
Auditorium, Classroom and
Terminal Chairs*



YouTEAM™
18



Tiger Up
22



Sail
26



Sail Mesh
28



HIP HOP
30

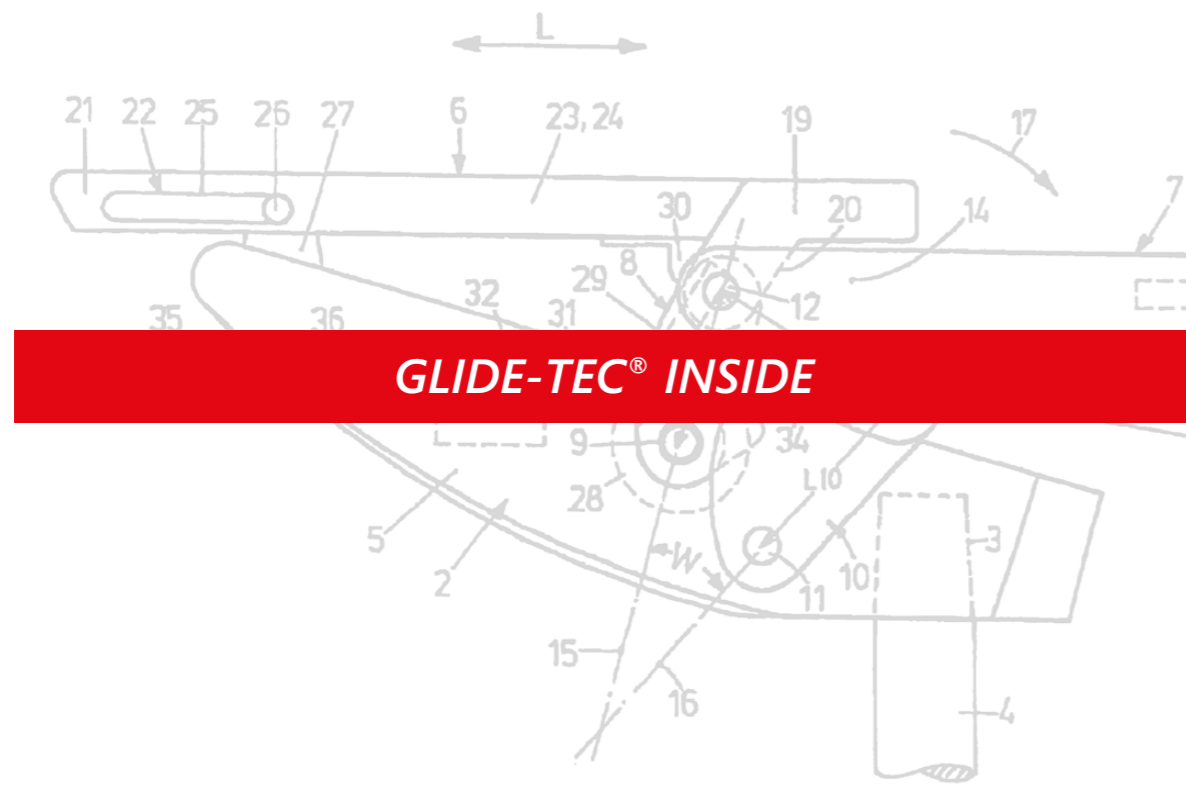

Dik Oturma Pozisyonu <i>Upright position</i>	Rahatlama Pozisyonu <i>Relaxed position</i>	Hareket Eden Omurga <i>Movement indicator joints</i>	Çalışma Alanına Uzaklık <i>Distance to the desk</i>	Çalışma Alanına Uzaklık (cm) <i>Distance indicator in (cm)</i>	Açıklama <i>Comment</i>
Tilt 		8		20	26 omurluk diskinden 8'i hareket ediyor ve kullanıcı çalışma alanından uzaklaşıyor. <i>Movement supported in 8 out of 26 considered joints. User distances himself from working area.</i>
Permanent 		7		20	26 omurluk diskinden 7'si hareket ediyor ve kullanıcı çalışma alanından uzaklaşıyor. <i>Movement supported in 7 out of 26 considered joints. User distances himself from working area.</i>
Senkron 		8		20	26 omurluk diskinden 8'i hareket ediyor ve kullanıcı çalışma alanından uzaklaşıyor. <i>Movement supported in 8 out of 26 considered joints. User distances himself from working area.</i>
Glide-Tec® 		26		0	26 omurluk diskinden 26'sı hareket ediyor ve kullanıcı çalışma alanından uzaklaşmıyor. <i>Movement supported in 26 out of 26 considered joints. User does not distance himself from working area.</i>

Klasik ofis koltuğu mekanizmaları ile Glide-Tec® teknoloji mekanizmanın karşılaştırılması.
Comparison of the Glide-Tec® mechanism with classic office chair mechanisms.

Dünya çapında patentli GLIDE-TEC® teknolojisi ile akıllı oturma konforu - mükemmel ergonomi!

Sağlıklı ve doğru oturma, aslında koltuğun doğru ayarlanması ile ilgilidir.

Sağlıklı ve rahat oturma pozisyonu için üç temel özellik çok önemlidir:

Intelligent sitting comfort with worldwide patented GLIDE-TEC® technology – perfect ergonomics!

Correct sitting – primarily a matter of adjustment.

Three basic things are very important for a healthy and comfortable sitting posture:



1- Arkalık, ikinci bir sırt gibidir:

Arkaya bütün sırtınız ile yaslanın, bu pozisyonda omurganız ideal oranda destek alacaktır.

Bel ve kalçanın da koltuk arkasına değmesi gerekir.

1- Backrest as a second back:

Lean with your whole back on the backrest: in this way the whole spinal column is optimally supported. Your bottom should also touch the backrest.

2- Kolçaklar:

Kollarınızı bir yüzeye koyun, koltuk kolçaklarının dirseklerinizi desteklemesi gerekir.

Çalışma alanınız, kollarınızın altında ve kollarınıza paralel olmalıdır.

2- Armrests:

Rest your arms on the level. The armrests should cradle the elbows, the lower arms rest on the work surface.

3- Oturma yüksekliği:

Koltuğunuzun oturma yüksekliğini ayarlarken, baldırlarınızın koltuk oturmağına paralel olduğuna dikkat ediniz (> 90°).

3- Seat Height:

Adjust the seat height so that the thigh rests horizontally on the seat cushion (> 90°).



video

Daha iyi çalışma

Eller çalışma alanında kalır. GLIDE-TEC® hareketinizi korur ve hangi pozisyonda otursanız oturun rahat çalışmayı kolaylaştırır. İster yaslanarak ister dik oturun, elleriniz her pozisyonda çalışma alanında ve klavye ile temas halinde kalır.

Better working

The hands remain at the work place. GLIDE-TEC® keeps you moving – and simultaneously facilitates comfortable working in any sitting position. Regardless of whether you are reclining or sitting upright: Your hands remain in contact with the writing surface or keyboard in any position.

Daha iyi oturma

GLIDE-TEC®, her pozisyonda sırtınızı destekler. Otururken de sırtınız harekete ihtiyaç duyar. Sağlıklı ve istikrarlı bir omurga, yaslanarak oturma ve dik oturma arasındaki sürekli değişimler ile beslenmelidir. GLIDE-TEC®, benzersiz patenti ile yaslanarak oturma/ dik oturma geçiş hareketlerini sağlar ve her oturma pozisyonunda sırtınızı destekler.

Better sitting

GLIDE-TEC® supports your back in any position. Your back needs movement – also while sitting. After all, a healthy and stable spine is promoted through the constant change between a hollow and rounded back. GLIDE-TEC®, with the unique lordosis/kyphosis patent, enables this movement while sitting and supports your back in any sitting posture.

Daha iyi rahatlatma

GLIDE-TEC®, kas gerginliğini önler. GLIDE-TEC® ile oturularak geçirilmiş uzun bir çalışma gününün sonunda bile formda kalabilirsiniz. Oturma şekliniz ne olursa olsun, yenilikçi aktif oturma teknolojimiz kas gerilmelerini önler. Boynunuz gerilmez ve kafanız her zaman rahat kalır.

Better relaxing

GLIDE-TEC® prevents muscle tension. With GLIDE-TEC®, you remain fit – even at the end of a long working day in a seated position. Regardless of which sitting posture you prefer our innovative seating technology actively prevents muscle tension. The neck is not over extended and always remains relaxed – and your head remains clear.



Dik oturma

Upright sitting



Yaslanarak oturma

Leaned back sitting



İki hareketin düzenli değişimi ile doğru ve sağlıklı oturma!

Correct sitting with healthy, changeable movement!

Dik oturma pozisyonunda (Lordosis)

- Disklerdeki basınç artar.
- Diskler arasında eşit bir basınç dağılımı gerçekleşir.

Yaslanarak oturma pozisyonunda (Kyphosis)

- Disklerdeki basınç azalır.
- Omurgadaki esneme/gerilme ile diskler beslenir.

Her iki pozisyonda da uzun süre kalınmazsa ve bu değişim düzenli yapılırsa sağlıklı oturma sağlanmaktadır.

With a slight hollow back (Lordose)

- Puts pressure on the spinal discs.
- Equal pressure on the spinal discs.

With a slightly rounded back (Kyphose)

- Unburdens the spinal discs.
- Allows the spinal discs to have a nutrient flow, since the suction draws nutrients in.

Both sitting postures are good – if they are not held too long.





Designer
2DODESIGN STUDIO



German Design Award 2017



reddot award 2016
winner

Red Dot Award 2016



YouTEAM™ HB UPH Comfort



YouTEAM™ HB UPH



YouTEAM™ HB Mesh



YouTEAM™ LB UPH



YouTEAM™ LB Mesh



Intuitive mechanism
integrated into the seat



Easy-to-read
pictograms

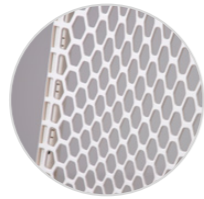

Elasto-net backrest (option) made of
synthetic recyclable and easy to keep
hygienically clean material



Three type of armrests
for different needs



Upholstered headrest for
high backrest version

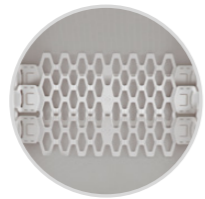

Comfortable lumbar
support



Hard/Soft floor



YouTEAM™ LB Elasto-Net



www

Tiger Up





Tiger Up 8 HA



Tiger Up 8 HA



Designer
Ray Carter

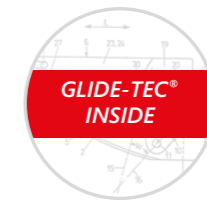

Patented GLIDE-TEC[®] mechanism



Multifunctional armrests



Tilting headrest



AirShape system



Hard/Soft floor



Tiger Up 8 HA



Tiger Up 6 HA



Tiger Up 4 A



Tiger Up 9 A



www



Tiger Up 5 A

Sail

Executive Office and
Managerial Chairs





Designer Ray Carter



Patented GLIDE-TEC® mechanism



Multifunctional armrests



Hard/Soft floor



Sail Mesh GT 8 MFA



Sail Mesh GT 6 MFA



Sail Mesh 7 A



Sail 7 A



Sail GT 6 MFA

Mesh colours

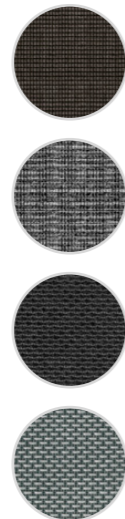

Sail Mesh CFA



Sail CFA



Sail Mesh 4LA



Sail 4LA



Sail GT 8 MFA



video



www



www



ergo mechanics

HIP HOP





HIP HOP 8

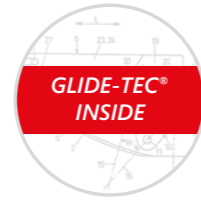

Patented GLIDE-TEC® mechanism



360-degree rotation adjustable metal armrests



Comfortable height adjustable headrest



Hard/Soft floor



HIP HOP 8



HIP HOP 6



www



HIP HOP 6



Designer Hilary Birkbeck



Innovation award 2015



02

Operasyonel Ofis Koltukları
Operative Office Chairs



NowyStyl

01

Executive Ofis ve Müdür Koltukları
Executive Office and
Managerial Chairs

03

Sofa ve Bekleme Koltukları
Sofas and Visitor Chairs

04

Kafe Koltukları
Café Chairs

05

Konferans, Tiyatro, Sinema,
Oditoryum, Derslik ve
Terminal Koltukları
Conference, Theatre, Cinema,
Auditorium, Classroom and
Terminal Chairs



WithME
36



Bello
40



S-Line Mesh
44



S-Line
47



4ME&2ME
48



Trevor
52



Frame
54



Navigo
56



Wave
58



Uno
62



Basis Mesh
64



Basis
66



Emo II
67



Deal
68



Line
69



CPC
70



Operative Office Chairs

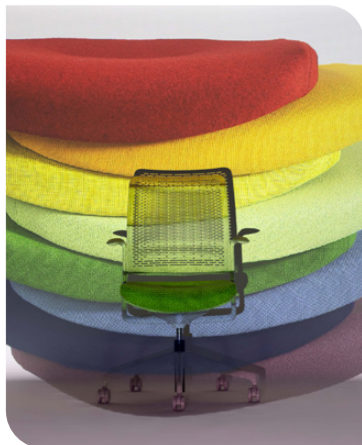



Designer
Martin Ballendat



German Innovation Award '21 Special



iF DESIGN AWARD 2023



WithME P Gri



WithME P Siyah



WithME D



Operative Office Chairs



www



video



ergo mechanics

Bello

Operative Office Chairs





Bello 40 A



Designer
Armin Sander



Diamond of Furniture Industry 2008



Pneumatic
lumbar support



Multifunctional
armrests



Upholstered
headrest



Hard/Soft floor



Bello 40 A



Bello 12 A



Bello 20 A



Bello 10 A



www

S-Line Mesh



Operative Office Chairs



S-Line Mesh 8+ MFA



S-Line Mesh 6+ MFA



S-Line Mesh 5 A



Backrest height adjustment



Multifunctional armrests



Adjustable headrest



Various mechanism options



Hard/Soft floor



S-Line 8+ MFA



S-Line 6+ MFA



S-Line 6+ Counter



www

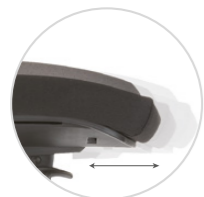

Seat depth adjustment



Negative seat inclination



Multifunctional armrests



Various mechanism options



Hard/Soft floor



S-Line 5 A



S-Line 4+ MFA



Designer
Ray Carter



www



Operative Office Chairs





Designer
Martin Ballendat



Diamond of Furniture Industry 2013



Meble Plus Product of The Year 2013



4ME 40 4D



4ME 20 4D



4ME Mesh 40 4D



www



4ME Mesh 20 4D

Operative Office Chairs



2ME 30 A



2ME 40 A



2ME 45 A



Height-adjustable backrest



Lumbar support



Adjustable headrest



3 different mechanisms



Seat depth adjustment



Adjustable or fixed armrests



Hard/Soft floor



www





Trevo 8 MFA



Trevo 7 MFA



Trevo 6 MFA



Trevo 9 MFA



Backrest height adjustment with (EasiLift)



Various mechanism options



Seat depth adjustment



Multifunctional armrests



Hard/Soft floor



Trevo 5 A



Trevo 4 MFA



Trevo 3 A



www

Designer
Peter Horn



Frame 8



Frame 6



Height adjustable lumbar support



2D armrests with hard polyurethane pads



Height and angle adjustable headrest



Optional seat depth adjustment



www





Designer Oscar Buffon



Navigo P



Navigo M



Various mechanism options



Hard/Soft floor



video



Operative Office Chairs





Wave 40 MFA



Seat depth adjustment



Various mechanism options



3D Mesh

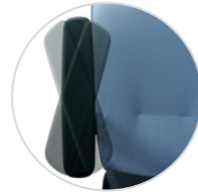

Multifunctional armrests



Hard/Soft floor



Wave 20 MFA



Wave 18 MFA



Wave 16 MFA



Wave 14 MFA



Wave 11 A-L



Wave 10 A-H



Wave 8 A-L



www



Uno 30 MFA



Seat depth adjustment

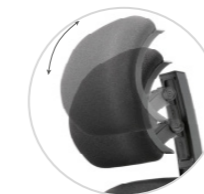

Adjustment headrest



Multifunctional armrests



Hard/Soft floor



Uno 40 MFA

Operative Office Chairs



Uno 20 MFA



Uno 18 MFA



Uno 16



www



Basis Mesh 40 MFA



Basis Mesh 30 MFA



Basis Mesh 16 MFA



Basis Mesh 14 MFA



Basis Mesh 20 A



Basis Mesh 12 A



Basis Mesh 10 A



Basis Mesh 18 MFA



Various mechanism options



Multifunctional armrests



Hard/Soft floor



Adjustable headrest



www



Operative Office Chairs





Basis 30 MFA



Basis 20 A



Basis 18 A



Various mechanism options



Multifunctional armrests



Hard/Soft floor



Basis 8 A



Basis 12 A



Basis 12 T

DIN



www



Emo II 20 A



Emo II 18 A



Emo II 3 A



Various mechanism options



Hard/Soft floor

DIN



www



Deal 40 MFA



Deal 30 A



Deal 20 MFA



Deal 18 A



Deal 10 A



Seat depth adjustment



Multifunctional armrests



Adjustable headrest



Various mechanism options



Hard/Soft floor



www



Line 8 A



Leather upholstery



Upholstered armrests



Contoured backrest



Hard/Soft floor



www



Line 7 A



Line 6 A



Line 5 A



Line 3 A



CPC three-seater



CPC 7 MFA



CPC 2400 MFA



CPC 1100 RA



CPC 1100 T

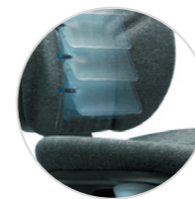

AirShape system



Various mechanism options

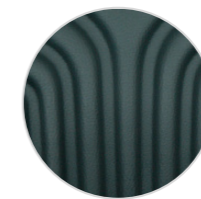

Vacuum technology



Multifunctional armrests



Hard/Soft floor



CPC 3402 A



www

03

Sofa ve Bekleme Koltukları
Sofas and Visitor Chairs



NowyStyl

01

Executive Ofis ve Müdür Koltukları
Executive Office and Managerial Chairs

02

Operasyonel Ofis Koltukları
Operative Office Chairs

04

Kafe Koltukları
Café Chairs

05

Konferans, Tiyatro, Sinema,
Oditoryum, Derslik ve
Terminal Koltukları
*Conference, Theatre, Cinema,
Auditorium, Classroom and
Terminal Chairs*



Fresh!
74



Reto
75



Poly
76



Match
78



Match Mesh
79



Kaika
80



Eva
82



Tilkka
84



Ciao!
88



Tutti
90



Athinas
92



Comodo
94



Mood
96



Club
98



Gala
100



Concerto
102



Estudo
104



Magnes II
106



Hexa
110



Fresh!



Fresh! Bank



www



www



Stackable



Poly



Poly W



Poly Net Mesh



Poly P



Upholstered backrest



Metal legs



Easy to store



Poly TB



Stackable



Poly TB



www



Match 30 A



Match 40 A



Match 45 A



Match Mesh 30 A



Match Mesh 45 A



Stacking up to 3 pieces



Armrests



Comfortable backrest



www



Kaika 25



Kaika 40



Kaika 38



Kaika 39



Kaika 42



Swivel column



Gas lift



Fully upholstered seat and backrest



www



Eva one-seater



www



Eva two-seater



Sofas and Visitor Chairs



Designer
NEED STUDIO



Tilkka 4L/W



Tilkka 4L/W two-seater



Tilkka 4L



Tilkka 4L two-seater



www



Designer
Giancarlo Bisaglia



Ciao! HB 40 two-seater



Ciao! LB 40 two-seater



Ciao! HB 38



Ciao! W



Ciao! LB 38



Mechanism that allows the user to rotate the armchair while sitting



Soft upholstered seat and backrest



Fully upholstered seat and backrest



Ciao! HB 40



Ciao! HB 42



Ciao! LB 40



Ciao! LB 42



www



Tutti LB one-seater



Tutti HB one-seater



Tutti LB two-seater



Tutti LB three-seater



Designer Jerzy Langier



Medium backrest



High backrest



Legs - metal, chromium-plated or powder-coated



Seat - flexible structure increasing the user's comfort



www



Athinas 25



Swivel mechanism



Fully upholstered



Gas lift



Athinas 38



Athinas 40



Athinas 42



www



Comodo 42



Comodo 42 two-seater



www



Mood one-seater



Mood two-seater



Mood A one-seater



Mood A two-seater

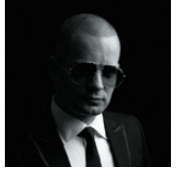

Designer
Michał Biernacki



Seat and backrest - fully upholstered and decorated with stitching



Characteristic embroidery and sophisticated details



Wide spacious seat



www



Club one-seater



Fully upholstered



Integrated armrests



Writing tablet



Club two-seater



Club three-seater





Gala one-seater



Gala two-seater



Gala three-seater



www

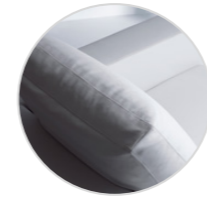

Concerto Armchair



Designer
Jerzy Langier



Concerto 2-Seater Sofa



Concerto 3-Seater Sofa



www



Estudo one-seater



Estudo two-seater



Estudo three-seater



Designer
Jerzy Langier



Writing tablet made of stained plywood



Frame on chromium-plated legs

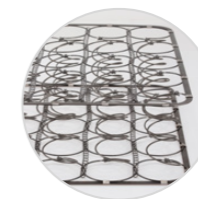

Seat and backrest - 120 mm and 75 mm Bonnel springs



Modernist, simple form



www



Sofas and Visitor Chairs



Designer
Arkadiusz Kulon



Upholstered seat



Possibility to upholster
the seat and cushion
in different colours



Unlimited configuration
possibilities



Multimedia port



Magnes II 101



Magnes II 103



Magnes II 110



Magnes II 501



Magnes II 200



Magnes II 201



Magnes II 211



Magnes II 502



Magnes II 203

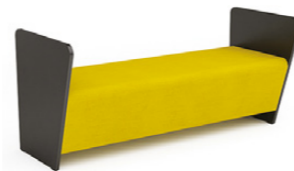

Magnes II 210

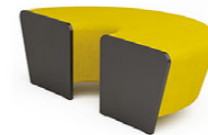

Magnes II 580 ZD



Magnes II 450



Magnes II 490 W



Magnes II 490 Z



Magnes II 601



Magnes II 300



www





Designer
Mac Stopa



Solid wooden structure



Possibility to combine
different upholstery colours
on a single module



Hexa 11L



Hexa 12L



Hexa 21L



Hexa 22L



Hexa 010



Hexa 11R



Hexa 12R



Hexa 21R



Hexa 22R



Hexa 020



Hexa 110



Hexa 120



Hexa 210



Hexa 220



Hexa Table 52



Hexa 112



Hexa 122



Hexa 212



Hexa 222



Hexa Table 72



www

04

Kafe Koltukları
Café Chairs

NowyStyl

01

Executive Ofis ve Müdür Koltukları
Executive Office and Managerial Chairs

02

Operasyonel Ofis Koltukları
Operative Office Chairs

03

Sofa ve Bekleme Koltukları
Sofas and Visitor Chairs

05

Konferans, Tiyatro, Sinema,
Oditoryum, Derslik ve
Terminal Koltukları
*Conference, Theatre, Cinema,
Auditorium, Classroom and
Terminal Chairs*Fondo
116Macao
118James
119Glen
119Café
120Beta
122Amigo
123



Plastic shell



Metal legs



Polypropylene shell (PP)



Chromium-plated frame (CR)



Stacking possibility up to 8 pieces



Fondo Hocker

Plastic colours

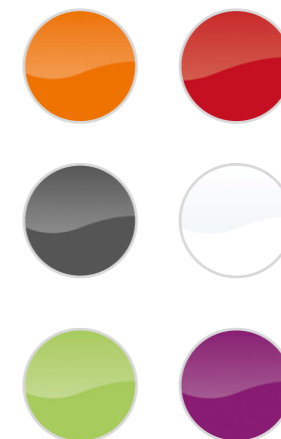

www



Designer
Neunzig° Design



reddot design award
winner 2011



Macao



Macao



Stackable



Macao RA



Macao RA



www



www



www



Café-Bingo Hocker



Café-VII Hocker



Café-Kobea



Café-II



Café-III



Café-IV



Café-V



Café-VI



Café-VII



Upholstered



Stackable



Decorative cut pattern on the backrest



Metal legs



Café-VII CFS



Café-IX



www



Plastic colours



Stackable



www



Plastic colours

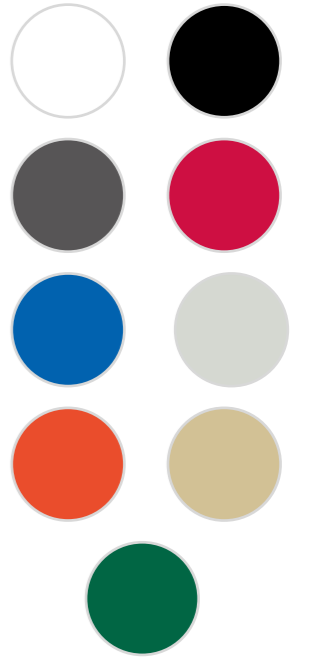

Stackable



www

05

Konferans, Tiyatro, Sinema,
Oditoryum, Derslik ve Terminal
Koltukları

*Conference, Theatre, Cinema,
Auditorium, Classroom and
Terminal Chairs*

GRAMMERoffice
projects

01

Executive Ofis ve Müdür Koltukları

*Executive Office and
Managerial Chairs*

02

Operasyonel Ofis Koltukları

Operative Office Chairs

03

Sofa ve Bekleme Koltukları

Sofas and Visitor Chairs

04

Kafe Koltukları

Café Chairs

05

GRAMMERoffice
projects

Index



Oscar
126



Tondo
130



Swing
132



Pablo
134



Event
138



Liza
140



Richard
144



Newton
148



Divo
152



Polyphony
156



Tom
160



Roma
162



Unit
164



Sempre
166



Theo
170



Vision
172



Vision HT
176



College
178



Foster
182



Henry
186



Enviro
187



Axo
190



Cadira
194



Scuola
196



Anno
198



Fly II 3D
200

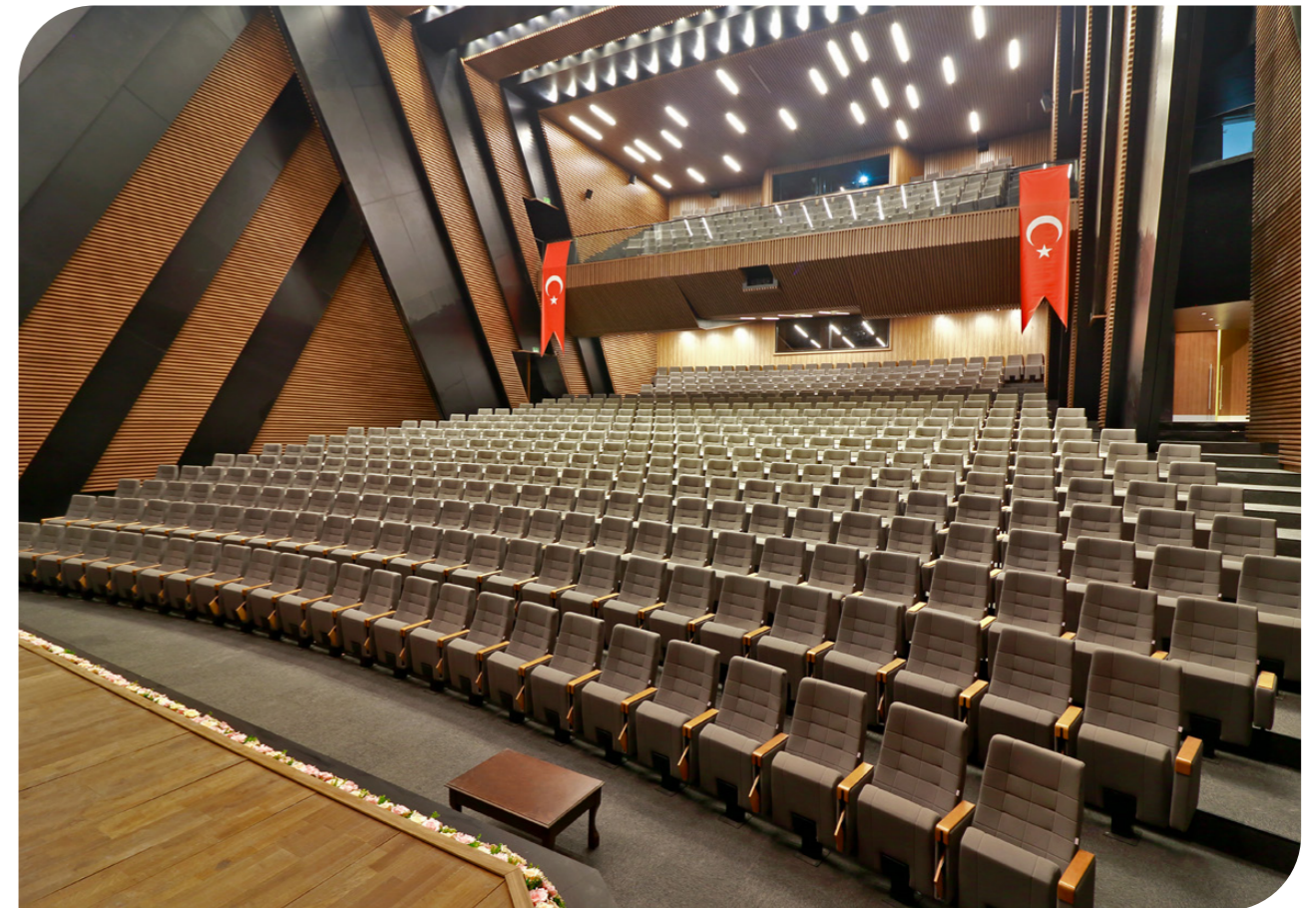

Conference, Cinema,
Auditorium Chairs

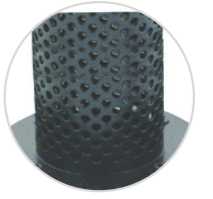

www

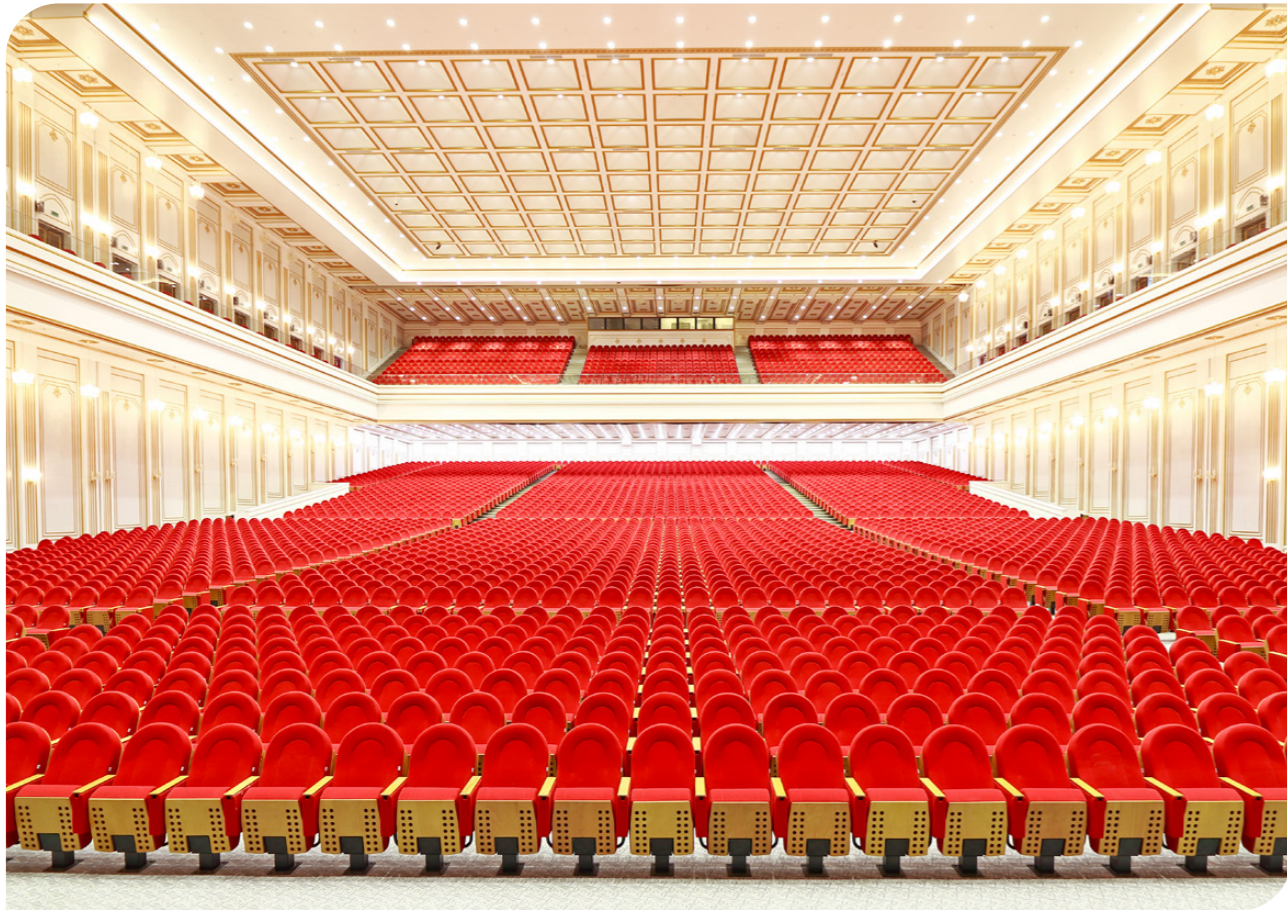

DIN



www



video



www

Pablo





Pablo W



www



www

Liza





www

Richard





www





DIN



www

Divo





www

Polyphony





Designer
Tomasz Konior



www

DIN



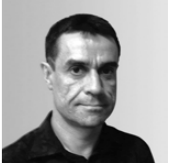

Designer
Stanisław Charaziak



www





www



DIN



www

Sempre

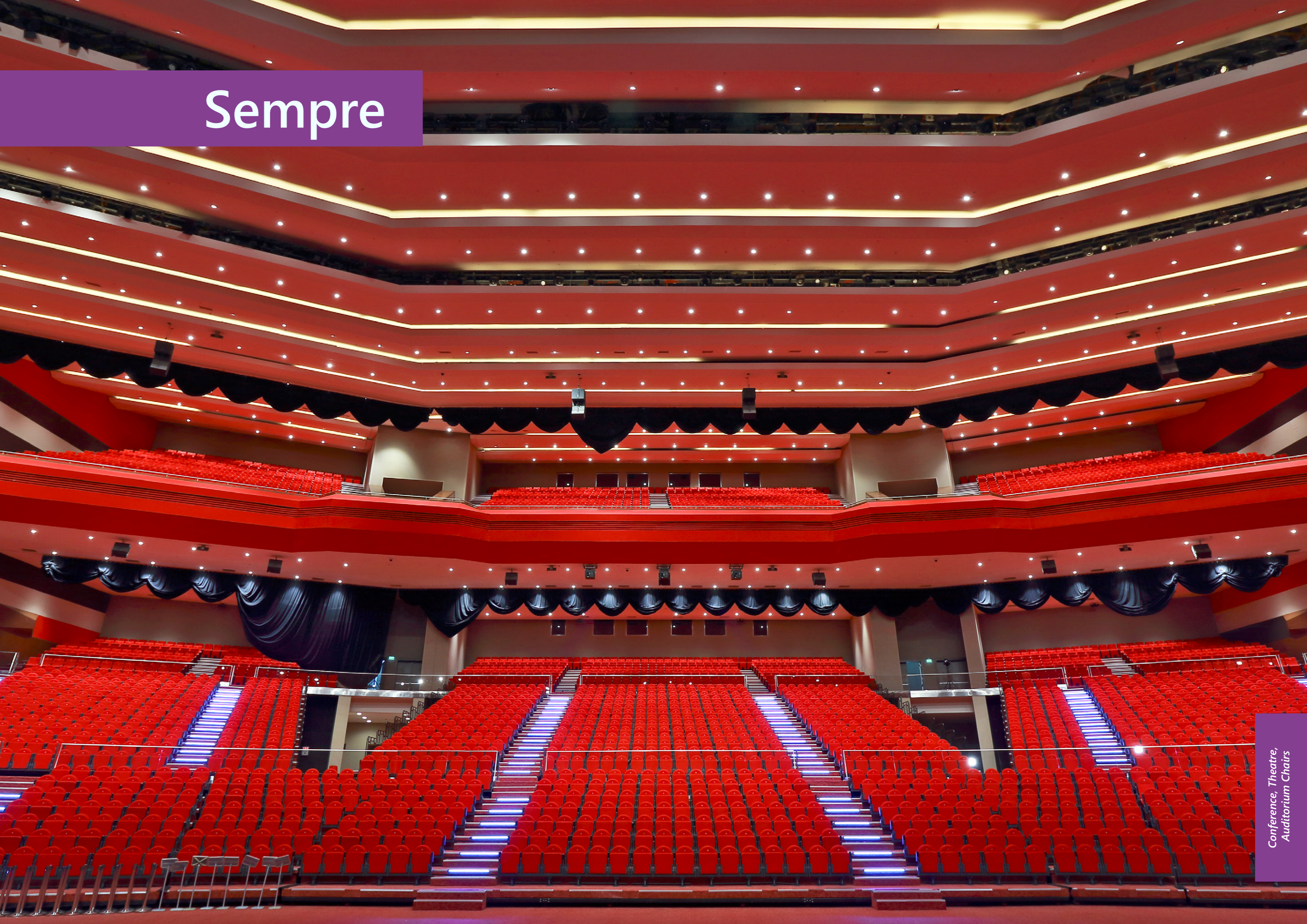

Conference, Theatre,
Auditorium Chairs



www



video





www

Vision





Vision 10 two seater (Front Panel+Mid Row)



Upholstered Front Panel



Vision 30 three-seater (Mid Row)

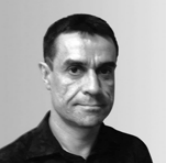

Designer Stanisław Charaziak



Vision 30 two-seater (End Row)



Writing tablet



www



Vision HT 10 two-seater
(Front Panel+Mid Row)



Vision HT 10 two-seater
(Mid Row)



Vision HT 10 two-seater
(Front Panel+Mid Row)



Vision HT 10 two-seater
(Mid Row)



www

College





Writing tablet



www



Foster





Writing tablet



www



Henry 10 R



www

Waiting Chairs



Enviro HA 30 TB



www



Enviro HA 30
(transport cart)

Conference, Waiting
Chairs



Stackable



Seat number



Writing tray



Interlink



Different wood colors



Embroidery



Row number



Enviro S 10



Enviro S 20



Enviro S 30



Enviro S 40



Enviro SA 10



Enviro SA 20



Enviro SA 30



Enviro SA 40



Enviro HA 10



Enviro HA 20



Enviro HA 30



Enviro HA 40



Enviro Bench 40
three-seater

Axo



Amphi, Classroom,
Conference Chairs



Designer
Jens Korte



Axo 10



Axo 20



Axo 30



Axo 10 A



Axo 20 A



Axo 30 A



Axo 10 TB



Axo 20 TB



Axo 30 TB



Axo 10 A TB



Axo 20 A TB



Axo 30 A TB



Axo 30 A TB



Stacking up to
10 pieces



Universal row
linking system



Link



Self-levelling glides
for soft and hard floors



Transport cart



Fixed numbering



Embroidery



www



Stacking up to 6 pieces



Cadira S 10



Cadira S 20



Cadira S 30



Cadira S 40



Writing tablet



Acoustic glides



Armrests with plastic pads



Armrests with wooden pads

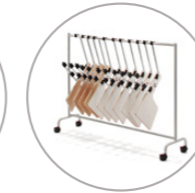

Tablet hangar



Embroidery



Cadira SA 10



Cadira SA 20



Cadira SA 30



Cadira SA 40



Cadira HA 10



Cadira HA 20



Cadira HA 30



Cadira HA 40



www



Dedicated support allows 360-degree rotation



www



Writing tablet



Upholstered

Anno TB



www



Anno 15





Yayılan gazların
%99'unu arıtıyoruz.

*We purify 99% of
emitted gases.*



Üretim atıklarının
%99'nunu arıtıyoruz.

*We purify 99%
of waste we produce.*



Enerji tasarrufu sağlayan
üretim teknolojilerine
yatırım yapıyoruz.

*We invest in energy
saving manufacturing
technologies.*



Termal enerji
üretiminde ahşap
atıklarını kullanıyoruz.

*We use wood waste
to produce thermal
energy.*



Koltuklarımızdaki plastik
parçaları geri
dönüştürülebilir üretiliyor.

*We recycle plastic to
make components of our
chair.*



Kumaşlarımızı EU Flower
sertifikalı ve işlenebilir
malzemelerden seçiyoruz.

*We use eu flower
certified fabrics and
processed material.*



Çalışanlarımız arasında
çevre dostu faaliyetleri
teşvik ediyoruz,
destekliyoruz.

*We promote envi-
ronmentally friendly
activities among our
employees.*



Ofis içi çalışmalarımızda
kağıt tasarrufuna dikkat
ediyoruz.

*We are economical
with paper in our
office work.*



Çevre politikamızı ISO
14001 standartlarına
uygun yürütüyoruz.

*Our environmental
policy is in accordance
with iso 14001.*



Öğrenciler için burs
fonu oluşturuyoruz.

*We fund scholarships
for students.*



Yerel toplumun
gelişmesine destek
veriyoruz.

*We care about the
development of our
local society.*



Yukarıdaki veriler/bilgiler, uluslararası
NSG şirketler grubuna aittir.
*All above given information pertain to
international NSG company group.*

TCC – The Chair Company A.Ş., ürünler üzerinde yapısal özellik, renk, döşeme ve komponent değişimi yapma hakkını saklı tutar.
TCC - The Chair Company A.Ş., reserves the rights to change the constructional features, colours, upholsteries and components of products.

©All rights reserved, TCC-The Chair Company A.Ş., Turkey

June 2026



NowyStyl

GRAMMERoffice
projects®

TCC-The Chair Company Büro Koltuk San. ve Tic. A.Ş.

Headquarter: Minareliçavuş OSB Mah. Ceviz Cad. No: 7 - 16220 Nilüfer / BURSA / TURKEY
Showroom: Büyükdere Cad. APA GİZ PLAZA No: 191 Kat: 2 - 34330 Levent / İstanbul / TURKEY

www.tcc.com.tr